

Cone Beam 3D Imaging
NewTom
what's next



Making Your Life Better.

BU Medical Equipment

Cefla Medical North America
6125 Harris Technology Blvd.
Charlotte, NC 28269
Ph: 704-598-0020

www.ceflamedicalna.com
info@cefladental.com

**Sede legale ed amministrativa
Headquarters**

Cefla s.c.
Via Selice Provinciale, 23/a
40026 Imola - Bo (Italy)
tel. +39 0542 653111
fax +39 0542 653344

**Stabilimento
Plant**

Via Bicocca, 14/c
40026 Imola - Bo (Italy)
tel. +39 0542 653441
fax +39 0542 653601

newtom.it



02/2024 NPXV5GB231500
According to the standards in force, in extra-EU areas the availability and specifications of some products and/or characteristics may vary. Please contact your local distributor for further information. Pictures are for illustration purposes only.

NewTom RX DC X-VS FULL.VISION

RX DC X-RAY UNIT AND INTRAORAL SENSOR



Cone Beam 3D Imaging
NewTom
what's next

RX DC INTRAORAL X-RAY UNIT.

Outstanding quality and innovation, exceptional features.

RX DC efficiency stems from a combination of advanced technology and an outstanding capacity to produce high definition images. The RX DC X-ray unit provides top-flight performance, practicality and technology. The RX DC features a constant potential high frequency (DC) generator and a very small focal spot (0.4 mm) capable of providing sharp, detailed images while ensuring working comfort and low doses for the patient.

Higher performance with RX DC, the X-ray unit that combines high definition imaging, ergonomic design and low X-ray doses.



SUPERIOR DIAGNOSTIC QUALITY

Obtained in just a few simple steps, all images are high resolution.



ADVANCED TECHNOLOGY

The NewTom RX DC high-frequency X-ray unit is based on NewTom's know-how with a 30 cm source distance and 0.4 mm focal spot.



MINIMAL RADIATION DOSE

Thanks to rectangular collimation and the ECO Mode parameters, the patient exposure to X-rays is minimal.



VERSATILE AND EASY TO INSTALL

Easy, fast installation with multiple positioning options. NewTom RX DC is available in both a wall-mounted and a trolley-mounted version.



USB CONNECT*

With USB Connect technology, RX DC communicates directly with the PC via a USB port. Integrated with the X-ray log, the system allows the delivered dose data to be digitally recorded and then associated with the patient's NNT-managed medical record. Dentists can display dose values, monitor them over time and send them to other applications via shared files.

*Optional

PRECISION DIAGNOSTICS.

Immediate diagnosis, excellent results.

Focal spot 0.4 mm and power 70 kV, 8 mA, high-frequency constant potential generator. Cutting-edge technology for extremely detailed images. The RX DC is extremely reliable: constant-potential design ensures image generation is unaffected by power fluctuations.



USER-FRIENDLY CONTROL

A practical, user-friendly handheld unit, designed for immediate, precise X-ray image acquisition, allows easy selection of the most suitable programme. Moreover, it allows users to control the exact emitted dose and the tube temperature via the sequential exposure graph. A wi-fi version is also available.

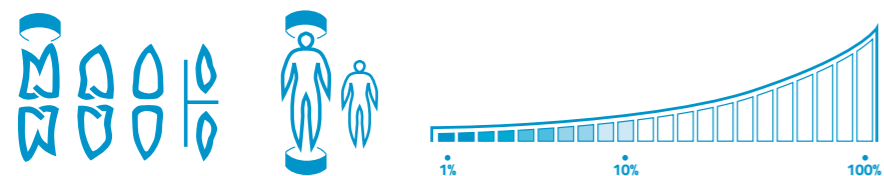

SUPERIOR PERFORMANCE AND TOP-CLASS ERGONOMICS.

Thanks to the protractor with graduated scale, positioning of the arms and the head is stable, effective and fully adaptable to your work. Consists of extruded aluminium arms with an integrated self-balancing system - available in the following lengths: 40 cm (15.7") - 60 cm (23.6") - 90 cm (35.4"). The adjustable wall support ensures maximum installation versatility.

Increased X-ray parallelism and an incorporated collimator allow the RX DC to achieve a source-to-skin gap of 30 cm. The RX DC provides pin-sharp, precise images with outstanding detail.

Extremely practical and versatile, RX DC can be used together with any type of direct or indirect digital sensor and X-ray film. Featuring 28 levels of sensitivity, it ensures sharp images in any situation.



The RX DC unit can also be set up with shutters and an (optional) rectangular collimator to define the body area that will be exposed and so reduce the received dose. Maximum attention to staff and patient health, while ensuring sharp, high definition image quality.

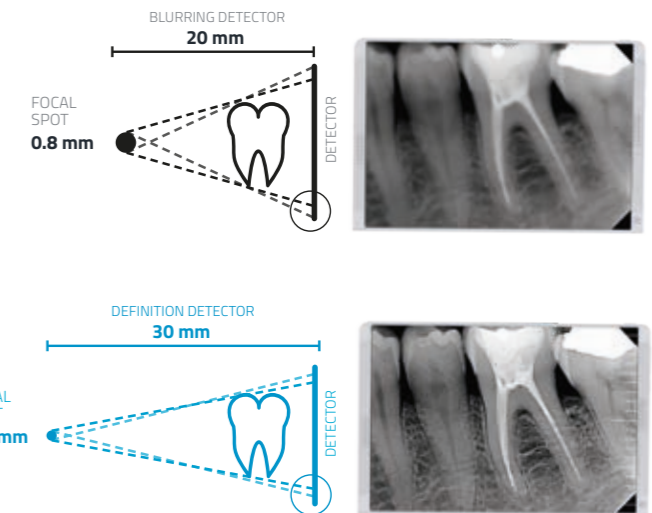

TROLLEY-MOUNTED VERSION
Maximised mobility for NewTom RX DC: a practical trolley allows the X-ray unit to be moved anywhere in the surgery.

X-VS INTRAORAL SENSOR.

For high quality
low dose dental
diagnostics.

Innovative ergonomics, direct USB plug-and-play connection, high definition and immediate results make the X-VS with HR technology the most advanced and suitable sensor for your surgery. Simplicity of use and image acquisition - combined with advanced real-time digital technology - improve quality of work.

The latest generation of X-VS image processing software aims to improve diagnostic efficacy. With excellent image resolution and an intuitive software interface, X-VS makes reading images easier and better suited to the purpose. This translates into a comfort zone personalized for each professional and for each appointment.



MULTI-VISION DIAGNOSTICS

High definition image acquisition in a few simple steps with filters optimised for every clinical need.



HR PLUG & PLAY DIGITAL TECHNOLOGY

FOP multilayer sensor, sturdy and reliable with direct USB connection.



OPTIMAL ERGONOMICS

Rounded profiles and ergonomic design to adapt to the oral cavity. Maximised active area ensuring an extended view.



INTEGRATED IMAGE MANAGEMENT

The NNT software manages, processes and shares the acquired images on PC; also visible on iPad**.



CUSTOMISED DIAGNOSTICS

Available in two sizes for maximum adaptability to the dimensions of the patient's oral cavity. Excellent working comfort and positioning, ensured by ergonomic sensors with rounded corners. A set of innovative filters allows customised tests to be carried out to improve the diagnostic vision.

WATERPROOF
WITH IP 67 PROTECTION RATING

RELIABLE AND ERGONOMIC.

Multivision for real-time quality diagnosis.

The X-VS intraoral sensor offers extraordinary performance, practical ergonomics and high technology, offering a perfect balance between comfort and cutting-edge technology. X-VS is impact-resistant, dust-resistant, IP67 certified (water-resistant) and can be used with all X-ray systems.

X-VS means real-time diagnostics, direct USB plug-and-play connection, high definition and immediate results. X-VS uses iRYS, the all-in-one software ideal for diagnostics, communication and management of intraoral imaging: perfect for storing, managing and printing images in perfect synchronism with any other devices already in the surgery.

INNOVATIVE ERGONOMICS

Ergonomic design, rounded corners and a flexible lead make the X-VS a practical, ergonomic and intelligent sensor. This speeds up the work and makes it more practical, maximising patient comfort. Designed to adapt perfectly to the anatomy of the oral cavity, X-VS maximises both the active area and positioning comfort. Ergonomic positioners ensure optimal sensor placement.

X-VS maintains a perfect combination of first-rate comfort and cutting-edge technology. Patient comfort is ensured by ergonomics and automatic acquisition, helping real-time diagnostics: it also allows the dentist/assistant to be always next to the patient for an uninterrupted workflow.

With X-VS the captured images are immediately displayed. Quick and easy sharing, communication and storage for an optimised workflow. Following acquisition, images are loaded directly onto the PC. From here they can be consulted, printed and shared via the iPad App** or a free image viewer.

** NOT available in USA and CANADA

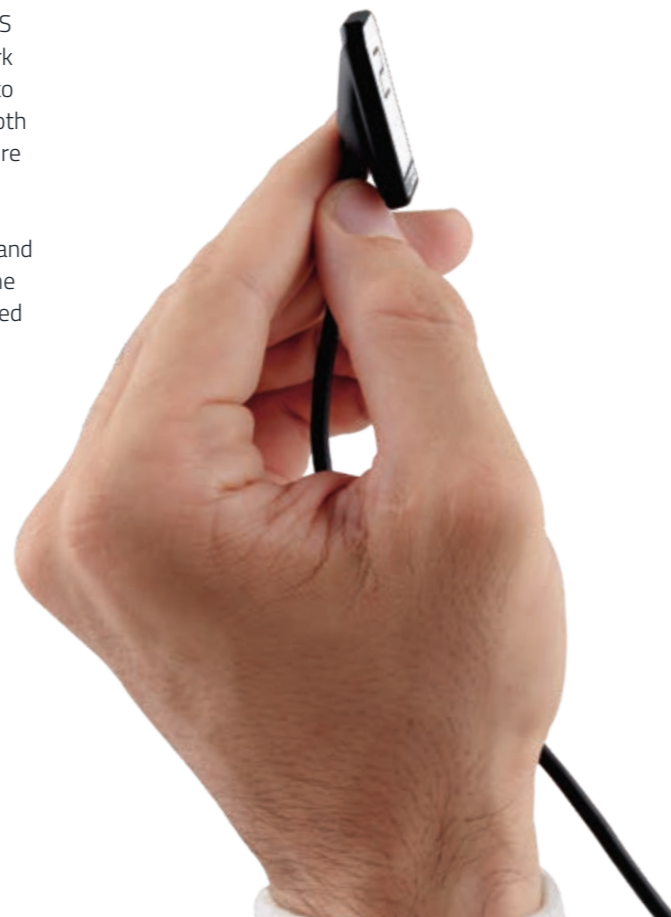

NEWTOM ADAPTIVE MULTIVISION

The innovative NewTom **ApT** (Adaptive Picture Treatment) filters have been specially developed to meet the needs of professionals. Thanks to proprietary algorithms optimized for the X-VS sensor, this function allows users to simultaneously acquire, display and share a set of images (up to 5), each with a specific improvement useful for highlighting anatomical details with different levels of sharpness. Equipped with the powerful NNT software, X-VS now allows more advanced and versatile image processing filters to be used in **Adaptive MultiVision** mode. You can select which filters to use from pre-set families or define customised ones based on individual diagnostic or visual preferences. This enhances diagnostic efficiency.

MULTILAYER SENSOR

Four-layer sensor, Caesium Iodide scintillator with column-like micro-structures that preserve image quality; intercepts the X-ray beam and converts it into visible light. The Fibre Optics Plate collimates the radiation onto the sensor and protects it against X-ray penetration. The CMOS acquisition device and the electronics convert the light into a high definition digital image

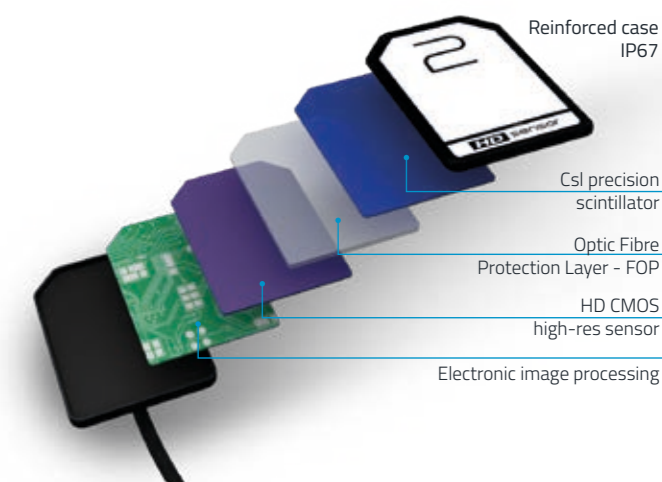

TECHNICAL SPECIFICATIONS.

RX DC X-RAY UNIT

Generator	Constant potential, microprocessor-controlled
Working frequency	145 - 230 KHz with self-adjustment (typically 175 KHz)
Focal spot	0.4 mm (IEC 336)
Total filtration	2 mm @ 60 kV / 2 mm @ 65 kV / 2 mm @ 70 kV (*)
Anode current	4 / 8 mA
Voltage at X-ray tube	60 / 65 / 70 kV (*)
Exposure times	0.020 - 1.000 seconds, R'10 and R'20 scale
Source-skin distance	20 and 30 cm
Irradiated field	∅ 60 mm and ∅ 55 mm (with round cone)
Additional collimators	35 x 45 mm (with rectangular cone for size 2 sensors) 31 x 41 mm and 22 x 35 mm, for size 1 and size 0 sensors
Power supply	50/60 Hz, 115- 120 V AC ±10% or 230-240 V AC ±10%
Duty Cycle	Continuous operation with self-adjustment up to 1s/90s total
Arms (for Standard version only)	Available in 3 lengths: 40 cm - 60 cm - 90 cm
Max arm extension	230 cm, from wall
Versions	Standard (wall mounted) or Mobile (on portable cart)
Dose delivered	Viewing on a handheld device with digital archive option on PC via NNT software which can be automated via the "USB connect" (optional) accessory
PC connection cable	Serial with USB adapter available in various lengths

(*) values depend on the country where the product is marketed

X-VS SENSOR

SIZE 1 - STANDARD

SIZE 2 - LARGE

Outside dimensions (mm)	38.9 x 24.9	41.9 x 30.4
Thickness (mm)	5.3	5.7
Pixel matrix	1500 x 1000	1700 x 1300
Pixel size (µm)	20	20
Max. resolution (lp/mm)	25	25
Grey level depth	14 bit acquisition - 16,384 maximum levels of grey	
Scintillator technology	CsI (Caesium Iodide) with micro-columnar structure	
Direct exposure protection	FOP (Fibre Optic Plate)	
Degree of Case protection	IP67 (Guaranteed against liquid or dust infiltration)	
Compatibility with X-ray generators	Any AC or DC technology X-ray generator with values in the 60 - 70 kV and 1-8 mA range and precision control of exposure times	

RX DC - X-VS SOFTWARE

Acquisition software (for PC)	iCapture for automatic archiving of RX DC exposure parameters on PC
Image management software (for PC)	NNT (compliant with ISDP®10003:2020 in accordance with EN ISO/IEC 17065:2012 - certificate number 2019003109-2) and iPad** NNT viewer App (free)
Protocols supported in NNT	DICOM 3.0, TWAIN, VDD5
DICOM Node Connectivity	NNT - IHE compliant (Print; Storage Commitment, SR document; WorkList; MPPS; Query/Retrieve)
X-ray log	NNT feature to associate exposure parameters with the X-ray images of each examination (exportable in PDF or CSV format)

RX DC - X-VS MINIMUM SYSTEM REQUIREMENTS

Supported operating systems	Microsoft® Windows® 10. 11 Professional 64 bit
Processor	Intel Core i3 or higher
Hard Disk	100 GB SSD (250 GB recommended)
RAM	4 GB (8 GB recommended)
Graphics card	Discrete 3D Video Card or integrated GPU
Display settings	1280 x 1024; 1344 x 768 or higher, 16 million colours
Port	USB 2.0 or later versions
Power supply	Use a power supply with suitable power for the video board in use

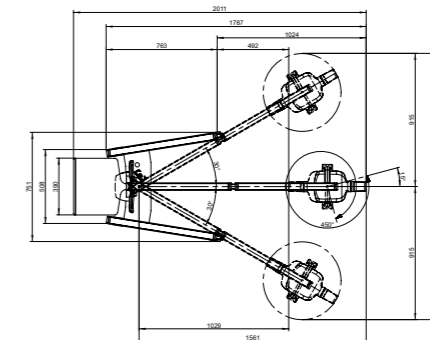
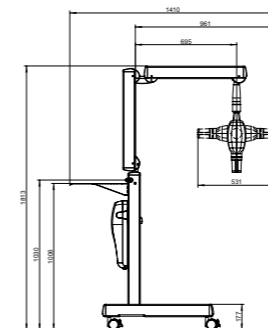
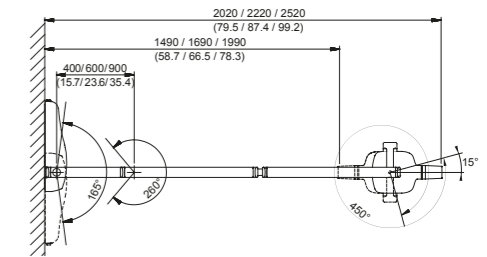
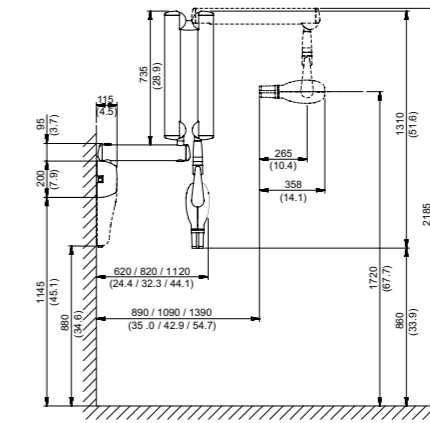
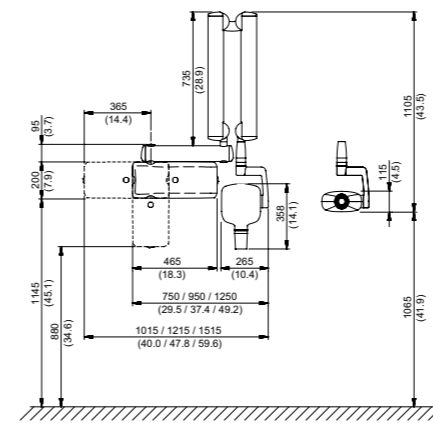

X-VS - 1

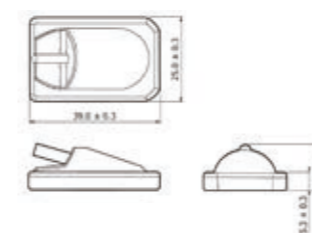

X-VS - 2

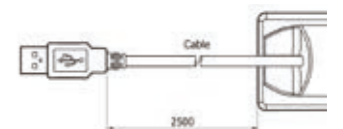
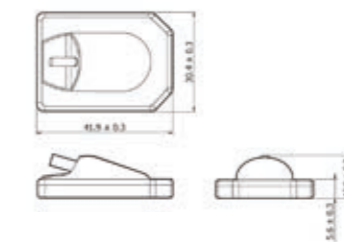

** NOT available in USA and CANADA
Specifications subject to change without prior notice.

Dimensions in centimetres
(dimensions in inches)